

Chimney Installation

Horizontal Termination

For 5 x 8 vent size create 10" x 12" vent termination opening

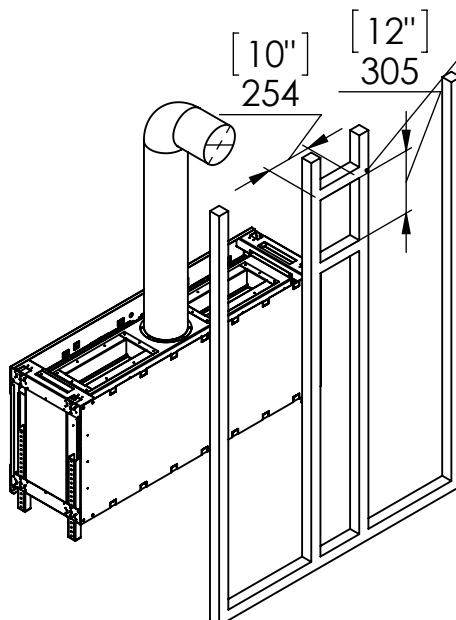

Vertical Termination

For 5 x 8 vent size create 10" x 10" vent termination opening

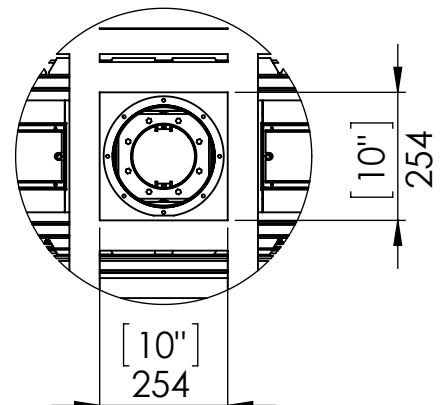
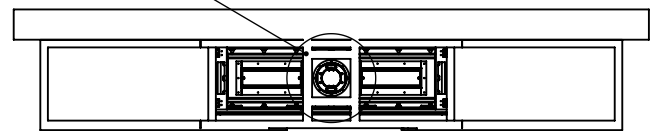

Flat Installation

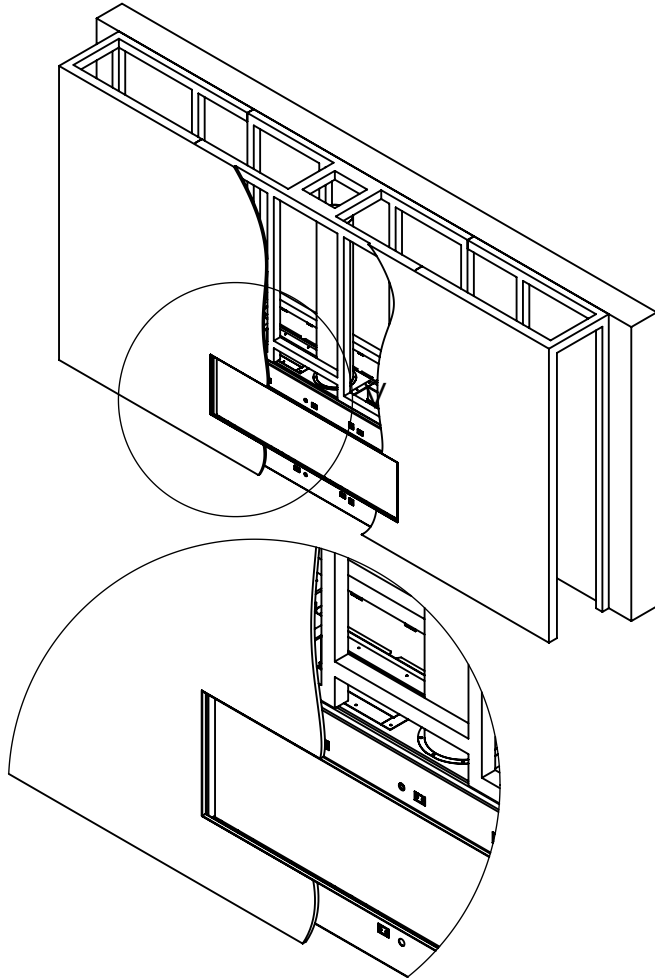

L Shape Installation

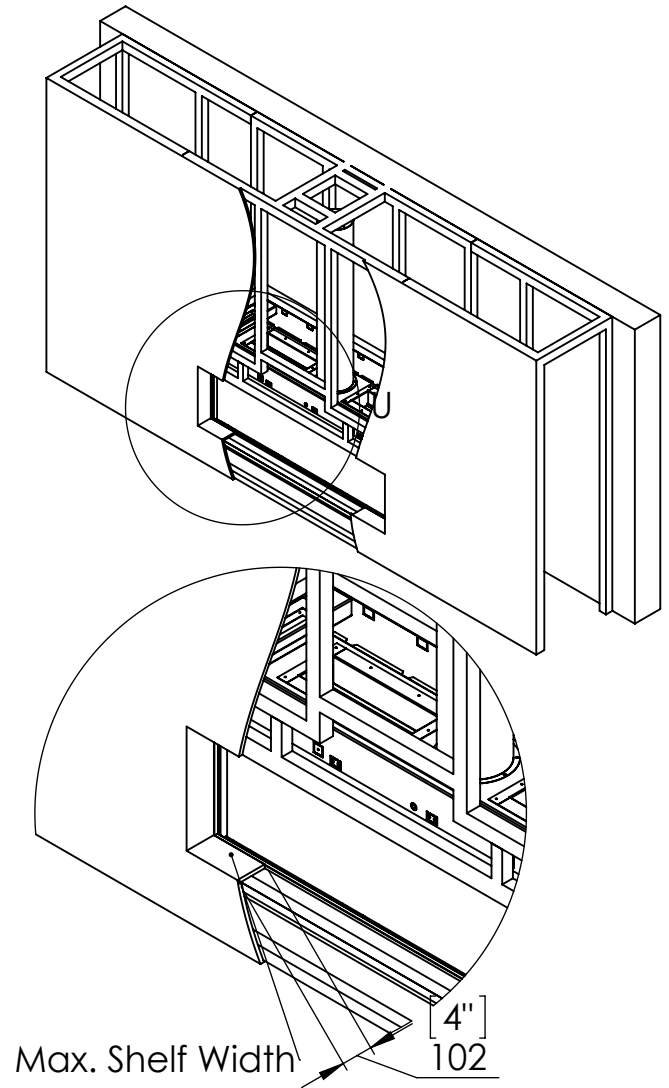

Step 1 - Basic Framing :

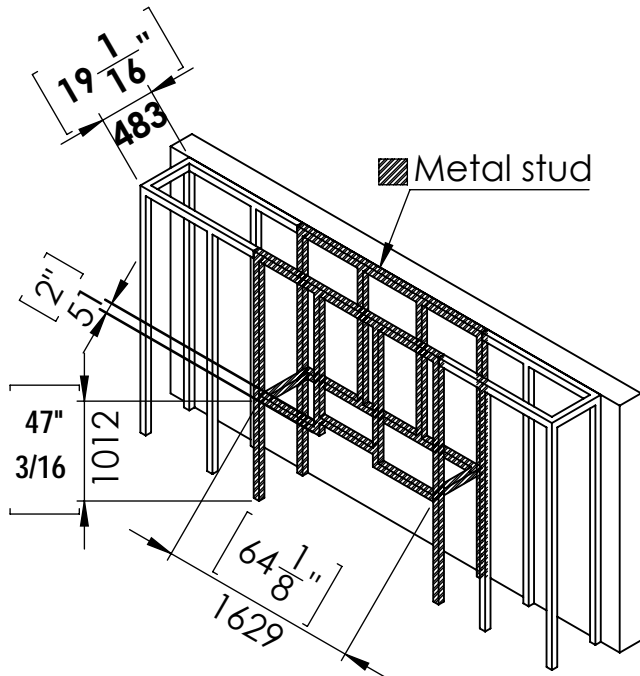

Step 1 - Basic Framing :

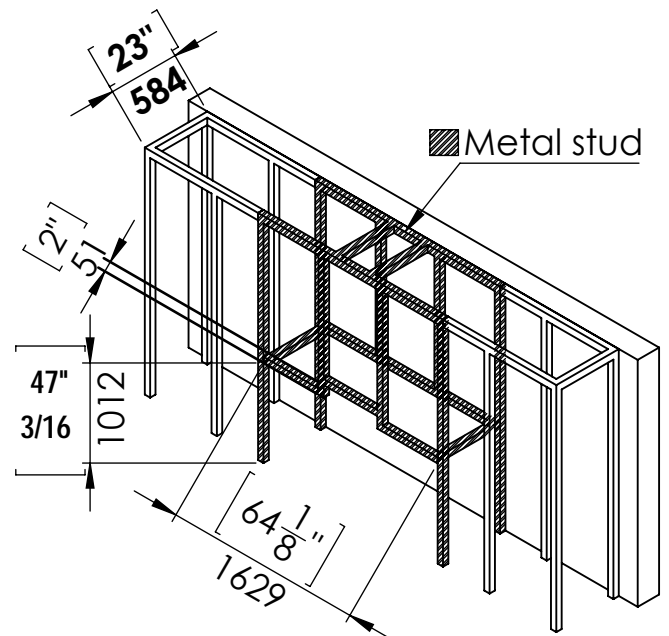

Flat Installation

Step 2 -Positioning the Fireplace:

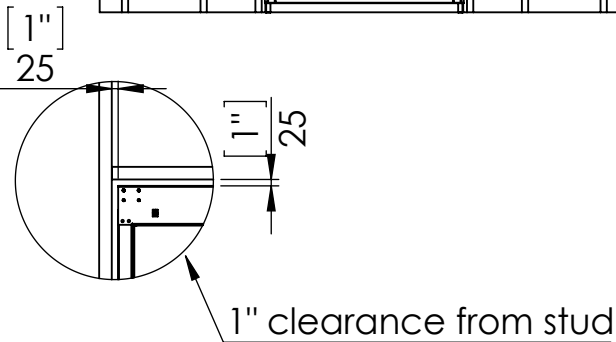
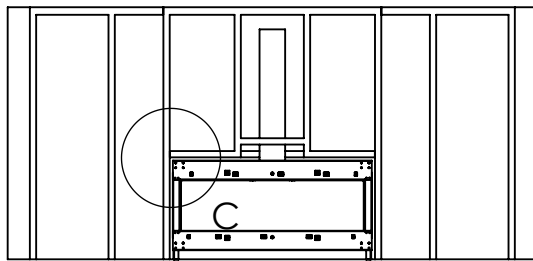
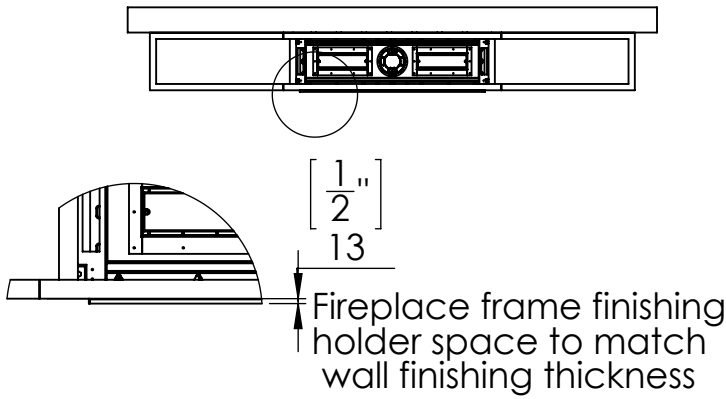

Last Step - Finishing The Fireplace Wall:

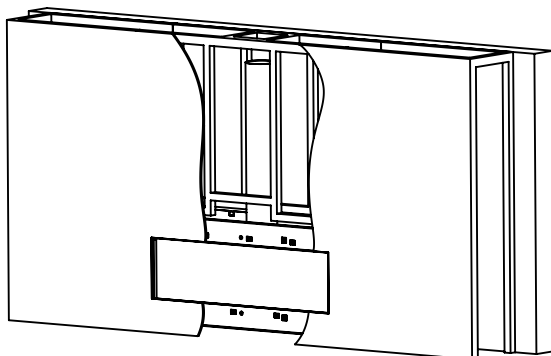

L Shape Installation

Step 2 -Positioning the Fireplace:

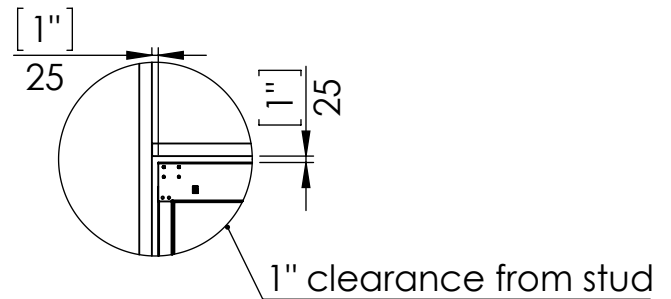
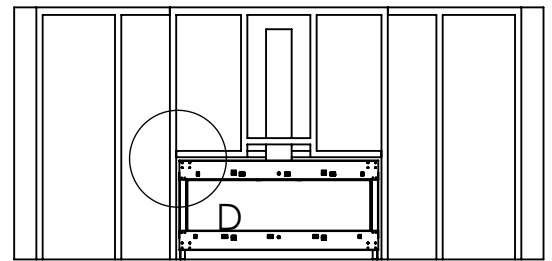
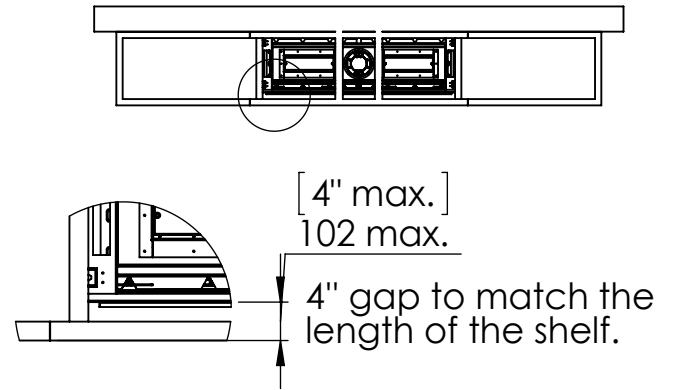

Step 3 - Framing Front Studs For L Shape:

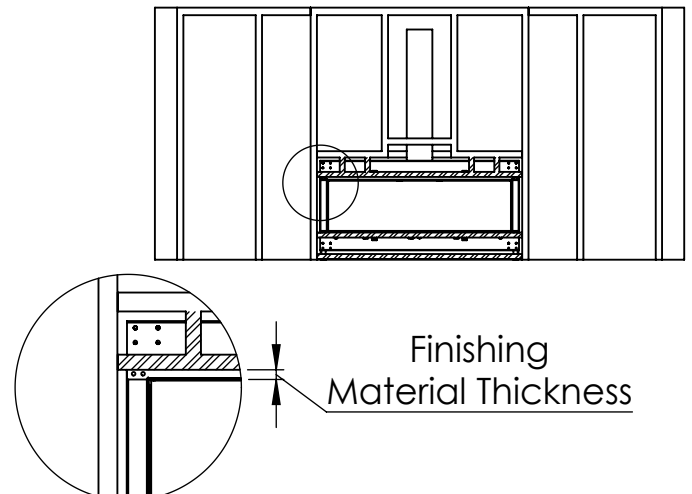

L Shape Finishing Install

Last Step - Finishing The Fireplace Wall:

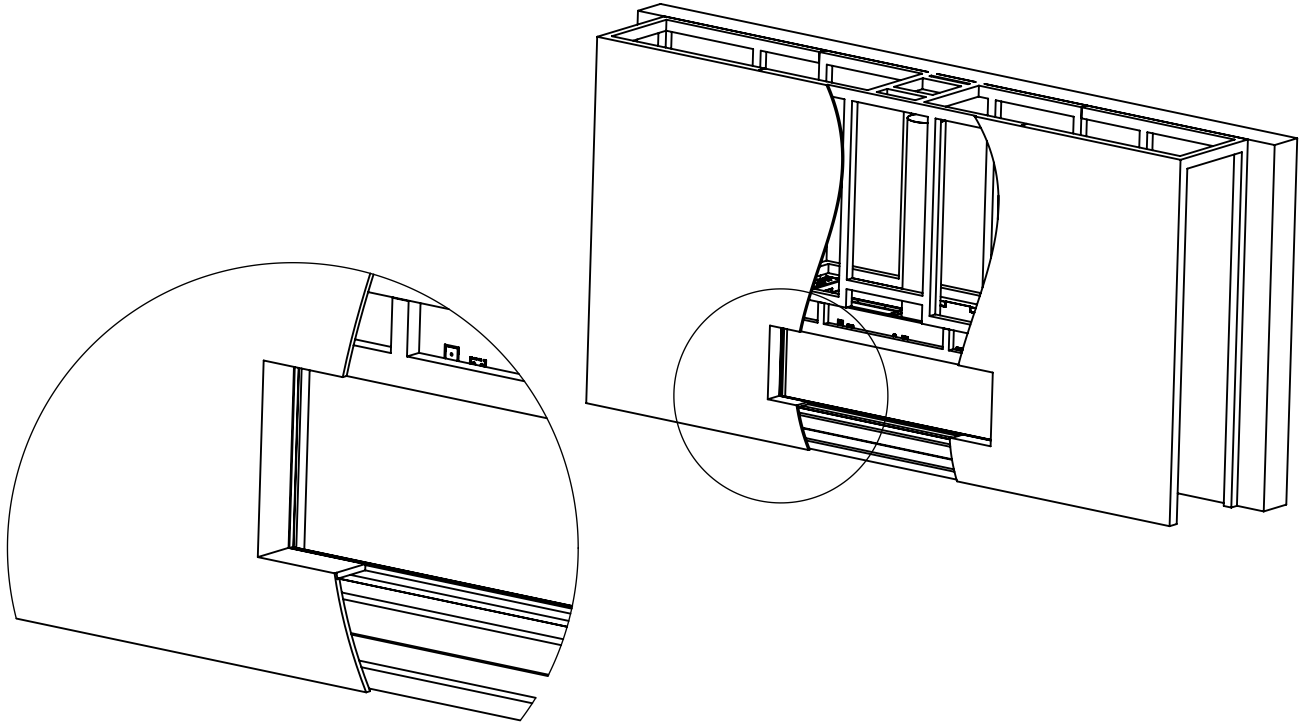

Specifications for Appliance

Flare Front 60 EH

Factor	NG	LPG
Burner Type	35,55,35	35,55,35
Orifice	550,650,550	160,160,160
BTU Max.	50000	41000
BTU min.	28000	20000
Kw/h	14.6k	10.2k
Chimney DIA.	5X8	5X8
Manifold Pressure[w.c]	3.3	10.4
Efficiency rate	77	80
Glass Size Length\Width	1450 X 767 mm	57" 1/16 X 30" 3/16
Appliance Weigh	210 kg	464 lb